

PHF FX20-22X32

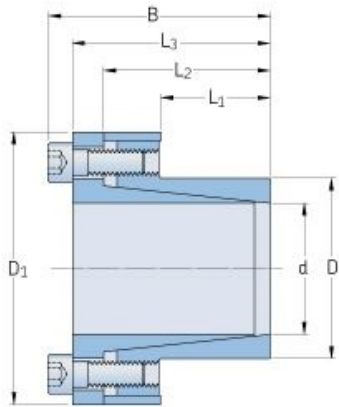

Bushing no.	FX20
d (mm)	22
d (in)	0.87
D (mm)	32
d_w (mm)	-
L (mm)	-
L_1 (mm)	25
L_2 (mm)	38
L_3 (mm)	45
B (mm)	51
D_1 (mm)	54
d_1 (mm)	-
e (mm)	-
F_t Transmissible axial force (kN)	22
M_t Transmissible torque (Nm)	250
P_w Shaft surface pressure (N/mm ²)	115
P_n Hub surface pressure (N/mm ²)	80
Clamp screws Qty	4
Clamp screws size	M6
Clamp screws nut	-
M_s Screw tightening torque (Nm)	17
Weight (kg)	0.34