

# PHF FX20-42X55

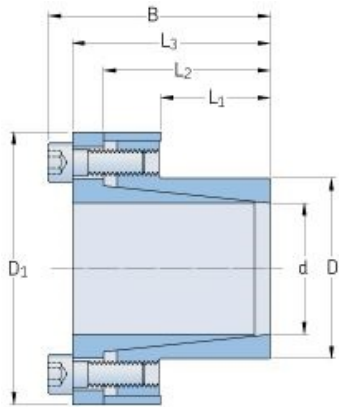

Bushing no.	FX20
d (mm)	42
d (in)	1.65
D (mm)	55
$d_w$ (mm)	-
L (mm)	-
$L_1$ (mm)	32
$L_2$ (mm)	45
$L_3$ (mm)	52
B (mm)	58
$D_1$ (mm)	78
$d_1$ (mm)	-
e (mm)	-
$F_t$ Transmissible axial force (kN)	45
$M_t$ Transmissible torque (Nm)	950
$P_w$ Shaft surface pressure (N/mm <sup>2</sup> )	90
$P_n$ Hub surface pressure (N/mm <sup>2</sup> )	70
Clamp screws Qty	8
Clamp screws size	M6
Clamp screws nut	-
$M_s$ Screw tightening torque (Nm)	17
Weight (kg)	0.76