

# PHF FX20-55X71

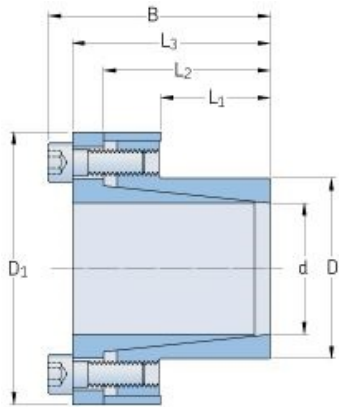

Bushing no.	FX20
d (mm)	55
d (in)	2.17
D (mm)	71
$d_w$ (mm)	-
L (mm)	-
$L_1$ (mm)	55
$L_2$ (mm)	72
$L_3$ (mm)	80
B (mm)	88
$D_1$ (mm)	98
$d_1$ (mm)	-
e (mm)	-
$F_t$ Transmissible axial force (kN)	94
$M_t$ Transmissible torque (Nm)	2600
$P_w$ Shaft surface pressure (N/mm <sup>2</sup> )	85
$P_n$ Hub surface pressure (N/mm <sup>2</sup> )	65
Clamp screws Qty	9
Clamp screws size	M8
Clamp screws nut	-
$M_s$ Screw tightening torque (Nm)	41
Weight (kg)	1.6