

PHF FX20-60X77

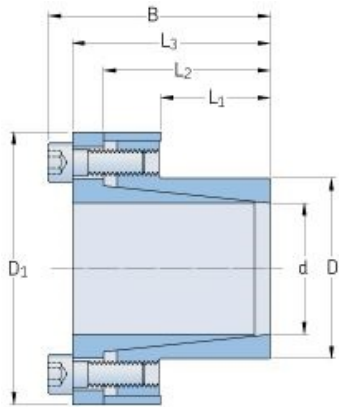

Bushing no.	FX20
d (mm)	60
d (in)	2.36
D (mm)	77
d_w (mm)	-
L (mm)	-
L_1 (mm)	55
L_2 (mm)	72
L_3 (mm)	80
B (mm)	88
D_1 (mm)	104
d_1 (mm)	-
e (mm)	-
F_t Transmissible axial force (kN)	94
M_t Transmissible torque (Nm)	2840
P_w Shaft surface pressure (N/mm ²)	75
P_n Hub surface pressure (N/mm ²)	60
Clamp screws Qty	9
Clamp screws size	M8
Clamp screws nut	-
M_s Screw tightening torque (Nm)	41
Weight (kg)	1.8