

PHF FX20-75X95

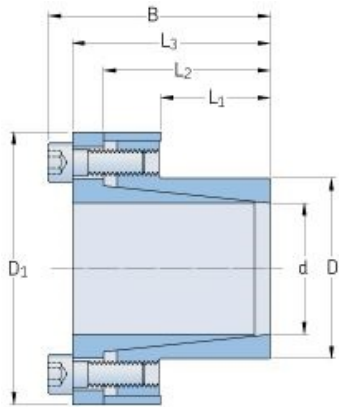

Bushing no.	FX20
d (mm)	75
d (in)	2.95
D (mm)	95
d_w (mm)	-
L (mm)	-
L_1 (mm)	65
L_2 (mm)	86
L_3 (mm)	96
B (mm)	106
D_1 (mm)	126
d_1 (mm)	-
e (mm)	-
F_t Transmissible axial force (kN)	150
M_t Transmissible torque (Nm)	5600
P_w Shaft surface pressure (N/mm ²)	80
P_n Hub surface pressure (N/mm ²)	65
Clamp screws Qty	9
Clamp screws size	M10
Clamp screws nut	-
M_s Screw tightening torque (Nm)	83
Weight (kg)	3