

PHF FX20-90X112

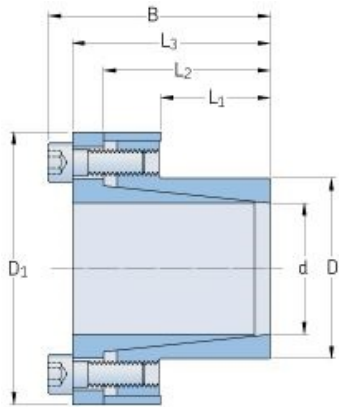

Bushing no.	FX20
d (mm)	90
d (in)	3.54
D (mm)	112
d_w (mm)	-
L (mm)	-
L_1 (mm)	65
L_2 (mm)	86
L_3 (mm)	96
B (mm)	106
D_1 (mm)	144
d_1 (mm)	-
e (mm)	-
F_t Transmissible axial force (kN)	200
M_t Transmissible torque (Nm)	9000
P_w Shaft surface pressure (N/mm ²)	90
P_n Hub surface pressure (N/mm ²)	75
Clamp screws Qty	12
Clamp screws size	M10
Clamp screws nut	-
M_s Screw tightening torque (Nm)	83
Weight (kg)	3.9