

PHF FX20-110X140

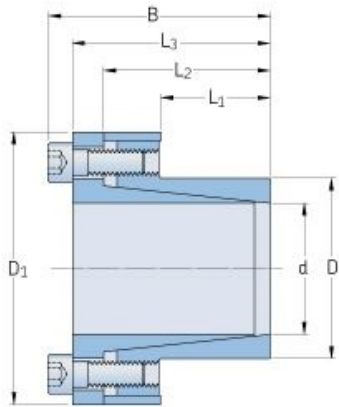

Bushing no.	FX20
d (mm)	110
d (in)	4.33
D (mm)	140
d_w (mm)	-
L (mm)	-
L_1 (mm)	90
L_2 (mm)	114
L_3 (mm)	128
B (mm)	140
D_1 (mm)	180
d_1 (mm)	-
e (mm)	-
F_t Transmissible axial force (kN)	290
M_t Transmissible torque (Nm)	16000
P_w Shaft surface pressure (N/mm ²)	80
P_n Hub surface pressure (N/mm ²)	65
Clamp screws Qty	12
Clamp screws size	M12
Clamp screws nut	-
M_s Screw tightening torque (Nm)	145
Weight (kg)	8.7