

# PHF FX90-35X45

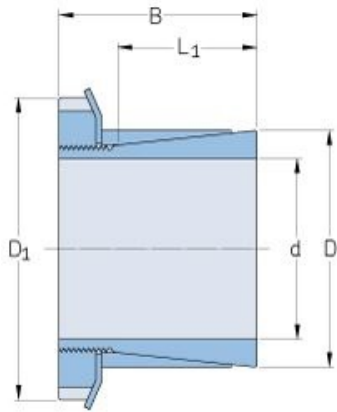

Bushing no.	FX90
d (mm)	35
d (in)	1.38
D (mm)	45
$d_w$ (mm)	-
L (mm)	-
$L_1$ (mm)	30
$L_2$ (mm)	-
$L_3$ (mm)	-
B (mm)	44
$D_1$ (mm)	58
$d_1$ (mm)	-
e (mm)	-
$F_t$ Transmissible axial force (kN)	21
$M_t$ Transmissible torque (Nm)	390
$P_w$ Shaft surface pressure (N/mm <sup>2</sup> )	55
$P_n$ Hub surface pressure (N/mm <sup>2</sup> )	45
Clamp screws Qty	-
Clamp screws size	KM8
Clamp screws nut	-
$M_s$ Screw tightening torque (Nm)	480
Weight (kg)	0.26