

PHF FX350-12X22

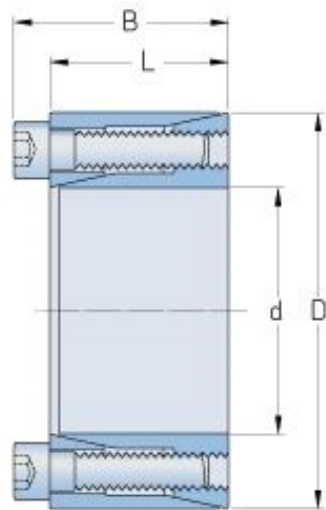

Bushing no.	FX350
d (mm)	12
d (in)	0.47
D (mm)	22
d_w (mm)	-
L (mm)	13
L_1 (mm)	-
L_2 (mm)	-
L_3 (mm)	-
B (mm)	15.5
D_1 (mm)	-
d_1 (mm)	-
e (mm)	-
F_t Transmissible axial force (kN)	-
M_t Transmissible torque (Nm)	20
P_w Shaft surface pressure (N/mm ²)	90
P_n Hub surface pressure (N/mm ²)	50
Clamp screws Qty	4
Clamp screws size	M2.5
Clamp screws nut	-
M_s Screw tightening torque (Nm)	1.2

® SKF is a registered trademark of the SKF Group

© SKF Group 2012

The contents of this publication are the copyright of the publisher and may not be reproduced (even extracts) unless prior written permission is granted. Every care has been taken to ensure the accuracy of the information contained in this publication but no liability can be accepted for any loss or damage whether direct, indirect or consequential arising out of the use of the information contained herein.

Weight (kg)	0.022
-------------	-------

® SKF is a registered trademark of the SKF Group

© SKF Group 2012

The contents of this publication are the copyright of the publisher and may not be reproduced (even extracts) unless prior written permission is granted. Every care has been taken to ensure the accuracy of the information contained in this publication but no liability can be accepted for any loss or damage whether direct, indirect or consequential arising out of the use of the information contained herein.

